

XVII CONGRESSO C.T.A
COSTRUIRE IN ACCIAIO: STRUTTURA E ARCHITETTURA

Napoli: 3 - 4 - 5 - Ottobre 1999
Vol. 1, pp. 193-204

**NEW CONFORMING PROCEDURES TO IMPROVE
THE DUCTILITY OF MR-FRAMES**

A. Anastasiadis¹, V. Gioncu¹ and F.M. Mazzolani²

¹ Department of Architecture, Politehnica University of Timisoara, 1900 Timisoara, Romania

² Department of Structural Analysis and Design, University of Naples, Italy

ABSTRACT

In this paper some new conforming procedures to improve the ductility of MR frames were examined by means of local and global analyses. The results indicate the superiority of modified moment resisting frames, designed according to the 'dogbone' and 'reinforced' concepts, as compared with the other configurations, considering the ductility requirements by different severe ground motions.

1. INTRODUCTION

The design philosophy of modern codes for earthquake resistant structures is based on the ability to dissipate energy through plastic deformations. It is generally recognized that, in order to design ductile moment resisting frames, dissipative zones have to be located in the beams ends rather than in the columns, leading to a collapse mechanism of the global type (Mazzolani & Piluso, 1996). So, the primary aim of the aseismic design is to achieve the balance between strength and ductility, avoiding collapse mechanisms having unsatisfactory energy dissipation capacity (i.e. storey mechanisms), by a proper proportioning and detailing of the structural elements. During the recent earthquakes, Northridge (1994), Kobe (1995), many brittle fractures of welded moment resisting frames, mainly located at the beam-column connections, were found, as well as unpredicted 'storey mechanisms' in the mid stories of the steel structures were observed. These recent events demonstrated that for an efficient earthquake design in highly seismic areas two aspects must be considered: firstly, the failure mode and ductility control must be assured, secondly, the important differences between the influencing earthquake characteristics (near-source vs far-source) must be

clarified in order to construct in high active seismic area, as Balkan and Mediterranean countries. The first approach can be obtained by using different concepts:

- by proper increasing of the rigidity of columns developing the well known strong column-weak beam concept (SC-WB) resulting the so-called Special Moment Resisting Frames, SMRF, having a collapse of the global type;
- by proper increasing or decreasing of the moment capacity of beam developing the new moment joints which move the plastic hinges away from the column face. In this way results the modified moment resisting frames, using the ‘dogbone’ solution, DB, or the ‘reinforced’ solution, RF, (Anastasiadis et al., 1999).

The second approach can be obtained by using, in case of inelastic analysis, of different accelerograms which introduces the specific site characteristics of the earthquake.

In this paper, new conforming procedures are presented and studied, from both local and global point of view, taking into account the ductility capacity. Different conforming frame typologies are analysed parametrical, considering the ductility requirements imposed by different sever ground motions.

2. WEAKENING AND STRENGTHENING OF THE BEAM

The modern concept of codes consider solutions of SC-WB MR frames with full strength, stiffness and ductile connections. Lessons learned from recent earthquakes have demonstrated a high stress concentration in the beam-column zone which greatly affects the rotation capacity of the components of nodal zone. For minimizing these effect and for improving the local ductility of the nodal zone, two solutions it is proposed: (i) by trimming the beam flanges near the beam column connections, results a weakened specific zone which assures the formation of plastic hinge in this zone due to a smaller moment capacity than required, (ii) by strengthening with plates the beam flanges at the beam-column zone, it is assured the movement of the plastic hinge far from the beam-column interface due to the excessive moment capacity of the beam. The first solution is the so-called ‘dogbone’ solution while the second one is the ‘reinforced’ solution. In Fig.1a,b it is presented the configuration and the main geometrical parameters, as well as the concept of ‘dogbone’ solutions sizing . The reduced plastic moments, $M_{p,red}^{(1)}$, $M_{p,red}^{(1)}$, for detailing the reduced beam section can be calculated as following:

$$M_{p,red}^{(1)} = (0.90...0.95)M_p \left[\left(\frac{2L_i}{L} - 1 \right) + \frac{1}{2\alpha} \frac{L_i}{L} \left(1 - \frac{L_i}{L} \right) \right] \quad (1.a)$$

$$M_{p,red}^{(1)} = (0.90...0.95)M_p \left[\left(\frac{2L_i}{L} - 1 \right) + \frac{1}{2\alpha} \frac{L_i}{L} \left(1 - \frac{L_i}{L} \right) \right] \quad (1.b)$$

where L is the beam length, M_p the unreduced plastic moment of the beam, $\alpha = M_p / qL^2$, vertical gravitational ratio. The direct dimensioning of the reduced flanges can be achieved with following relationships:

$$\frac{b_1}{b} = \left(1 + \frac{d^2 t_w}{4bt_f(d + t_f)} \right) \frac{M_{p,\text{red}}^{(1)}}{M_p} - \frac{d^2 t_w}{4bt_f(d + t_f)} \quad (2.a)$$

$$\frac{b_2}{b} = \left(1 + \frac{d^2 t_w}{4bt_f(d + t_f)} \right) \frac{M_{p,\text{red}}^{(2)}}{M_p} - \frac{d^2 t_w}{4bt_f(d + t_f)} \quad (2.b)$$

where b , d , t_f , t_w , are the dimensions of the cross-section. For ensuring the member hierarchy criterion, $\Sigma M_c \geq 1.2\Sigma M_b$, must be determined the moment at the face of the column which is going to be distributed at the columns:

$$M_{f.c} = \gamma M_{p,\text{red}}^{\text{med}} \left(1 + \frac{L_p}{L_{pd}} \right) + qL_p \left(\frac{L_{pd}}{2} - 1 \right) \quad (3)$$

where, $M_{f.c}$ is the moment at the column face, $M_{p,\text{red}}^{\text{med}}$, moment at the middle of the reduced zone, L_p , distance between the face of column and plastic hinge, L_{pd} , distance between the two plastic hinges and γ , the factor taking into account strain hardening effects, and random variability of the mechanical properties.

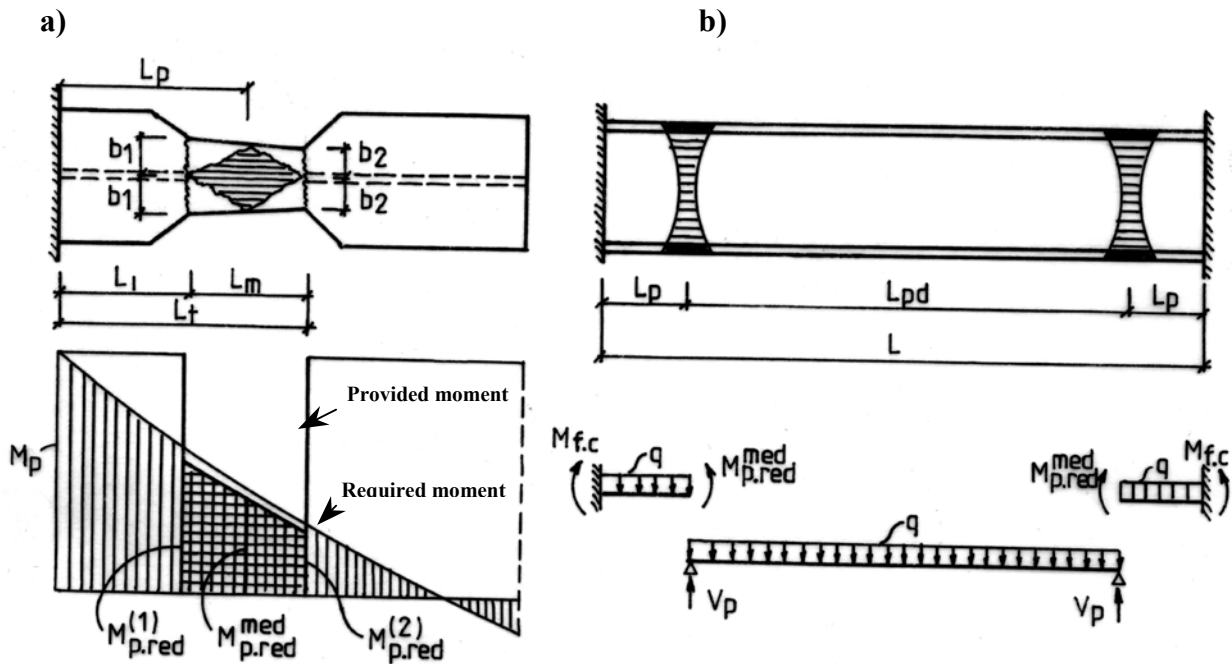

Figure 1: Weakening of the beam section

The influence of the reduced beam section on the member hierarchy criterion is plotted in Fig.2. One can see that weakening solution gives the possibility to reduce the column cross-section, respecting the SC-WB concept. For determining the local ductility of the ‘dogbone’ section the DUCTROT’ 97 computer program was used (Petcu & Gioncu, 1997). In Fig.3 is plotted the influence of the main geometrical parameters on the available plastic rotation capacity of the reduced beam section. It is observed that reducing the beam flanges of about 45% an increasing of ductility with about 40% is obtained as compared with the unreduced beam section.

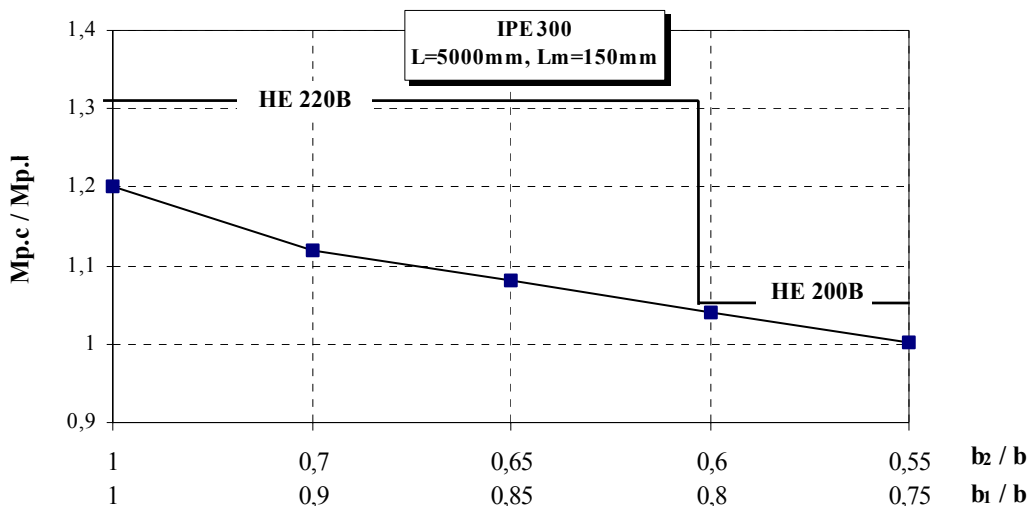

Figure 2: Influence of the ‘dogbone’ section on the member hierarchy criterion

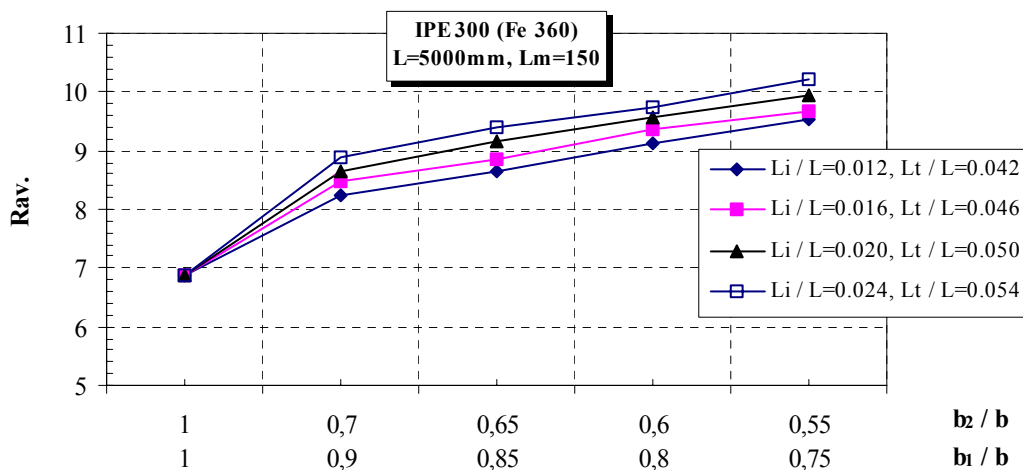

Figure 3: Influence of geometrical parameters on available plastic rotation capacity

A reinforced beam solution illustrating the main geometrical parameters, as well the concept of sizing such sections is presented in Fig. 4a,b. The over strength plastic moment of the strengthened beam section, $M_{p,STR}$, with which can be sized the reinforced section, can be calculated:

$$M_{p, str} = \gamma M_{p, b} \left[\left(\frac{2L_p}{L_{pd}} + 1 \right) + \frac{1}{2\alpha} \frac{L_{pd}^2}{L^2} \left(\frac{L_p}{L_{pd}} - \frac{1}{2} \frac{L_p^2}{L_{pd}^2} \right) \right] \quad (4)$$

where $M_{p,b}$ is the plastic moment of the unreinforced beam, L_p , distance between the face of column and plastic hinge which can be $L_r + h/3$ (as evidenced from experimental evidence, SAC), L_{pd} , distance between the two plastic hinges and γ is the factor taking into account strain hardening effects, and random variability of the mechanical properties. The strengthened plastic moment from relation (4) is going to be distributed at columns in order to verify the SC-WB concept. The influence of reinforcing the beam section on member hierarchy criterion is plotted in Fig.5. One can see that the increasing of ribs length leading to an increase of columns section, having an unfavourable economical impact on the structure. The influence of ribs length and plastic hinge position on the rotation capacity is presented in Fig.6. The plastic rotation capacity of the reinforced beam section is greater than the unreinforced section of about 15%. Comparing these two analysed solutions it can be observed the superiority of ‘dogbone solution, which improves local ductility keeping constant or reducing the dimensions of columns.

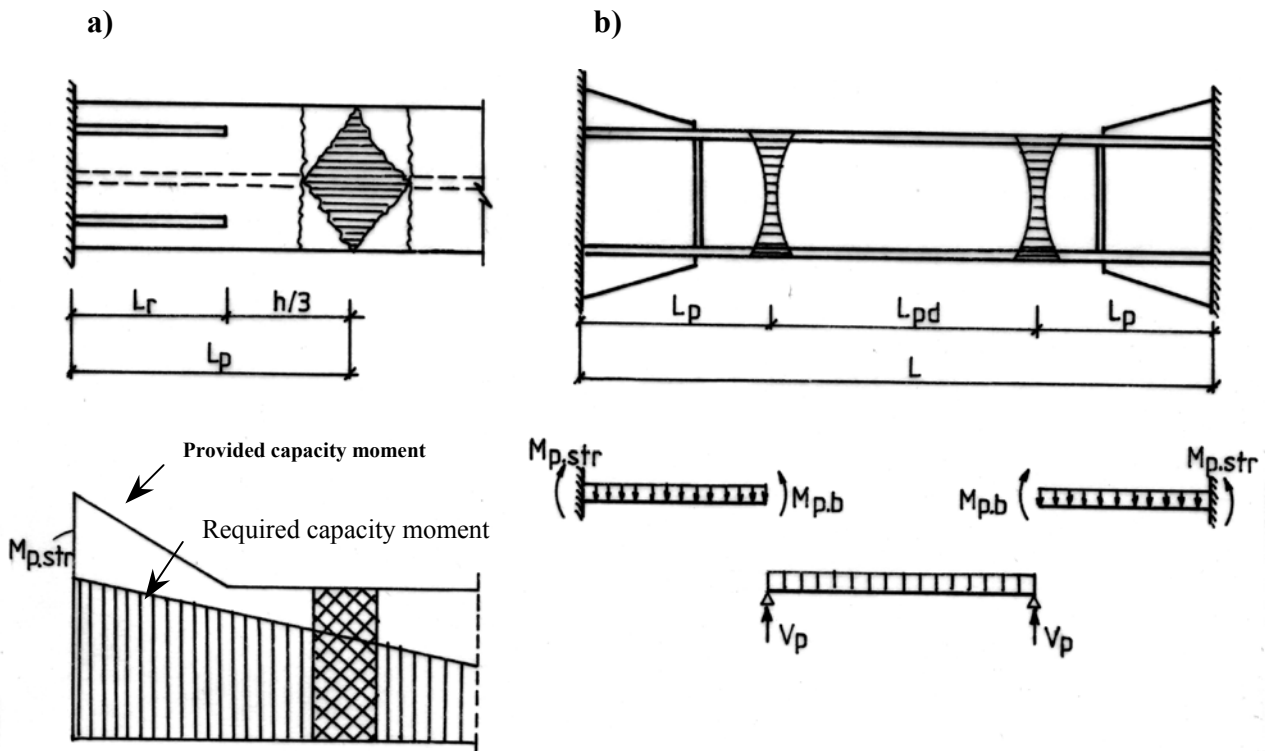

Figure 4: Strengthening of the beam section

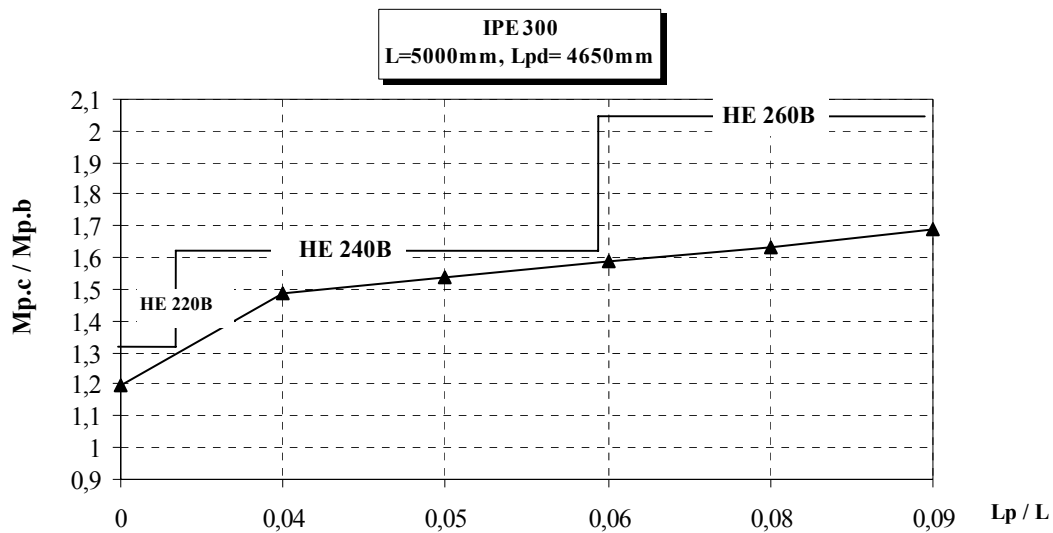

Figure 5: Influence of the reinforced section on the member hierarchy criterion

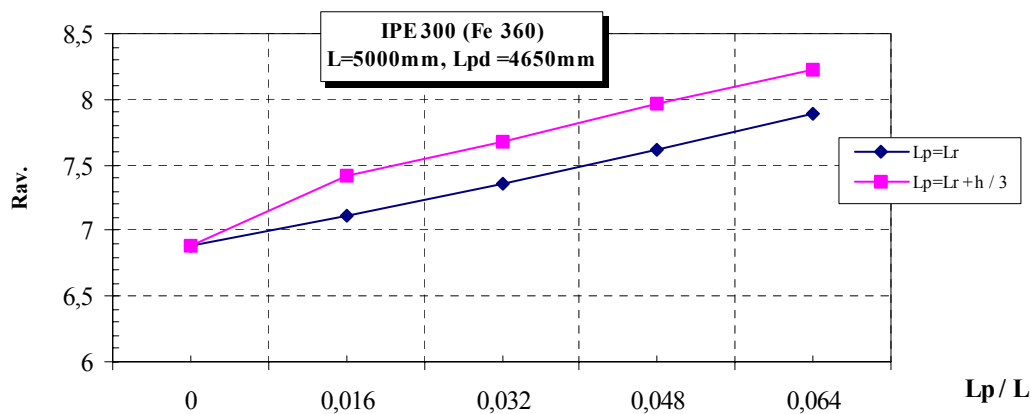

Figure 6: Influence of geometrical parameters on available plastic rotation capacity

3. GLOBAL PERFORMANCE OF THE IMPROVED MRFs

In order to investigate the global performance of the new conforming procedures, a parametrical study is developed on the 3 storey-2 bay frame, Fig.7, considering ordinary moment resisting frames, OMRF, special moment resisting frames, SMRF, and OMRF using the ‘dogbone’ section, OMRF-DB, and reinforced section, OMRF-RF. The parametrical characteristics of the frames are given in Table1. The OMRF-DB1 has a smaller reduced beam section and bigger column cross-section, according to Fig.2, than the OMRF-DB2, while the OMRF-RF1 has a smaller rib length and column cross-section as compared cu OMRF-RF2, according to Fig.5, Table 1. The frames was subjected to different scaled ground motions, considering the high seismicity level (Mazzolani & Piluso, 1994), Table 2. The dynamic inelastic analysis was performed using DRAIN-2D computer program. The main parameters, which have been investigated for evaluating the global inelastic response, are the mechanism type and the maximum plastic rotation of the beams and columns.

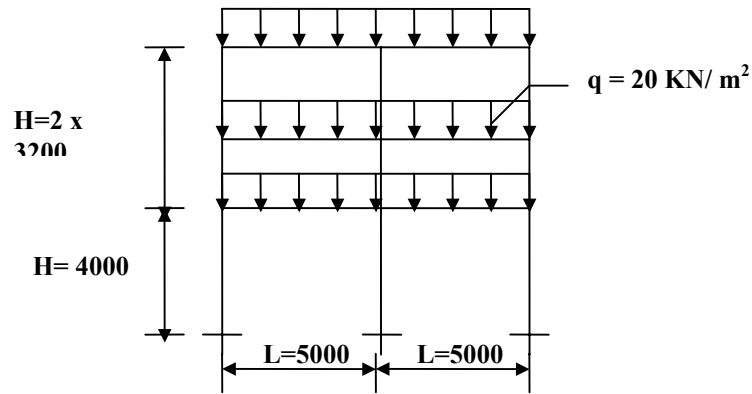

Figure 7: Geometrical characteristics of the analysed frames

Table 1: Characteristics of the different frame typologies

Type of frame	Column	Beam	Material	b_1 / b	b_2 / b	L_p / L	$M_{p,c} / M_{p,b}$
OMRF	HE 220B			1.0	1.0	0.0	1.31
SMRF	HE 280B			1.0	1.0	0.0	2.44
OMRF-DB1	HE 220B	IPE 300	Fe 360	0.90	0.70	0.07	1.17
OMRF-DB2	HE 200B			0.70	0.55	0.07	1.02
OMRF-RF1	HE 220B			-	-	0.02	1.00
OMRF-RF2	HE 240B			-	-	0.04	1.12

Table 2: Characteristics of the different frame typologies

Earthquake	Recorded	Component	Epicentral distance (Km)	P.G.A (g)	Scaled P.G.A (g)
Zakynthos, 1988	-	Long	11.0	0.127	0.35
Kalamata, 1986	Nomarhia	Long	13.0	0.239	
Kobe, 1995	JMA	N-S	18.0	0.296	
Aigio, 1995	OTE	Transv.	18.0	0.543	
Northridge, 1994	Canyon Count.	N90W	25.12	0.455	
Mexico, 1985	SCT	E00W	400.0	0.17	

Analysing the results presented in Fig. 8,9, in function of earthquake characteristics, the following conclusions should be emphasized:

- in case of far-source earthquakes (Mexico) an ordinary moment resisting frame, OMRF, which develops a storey mechanism, can be transformed in a special moment resisting frame, SMRF, with the application of the ‘dogbone’, OMRF-DB1, DB2, and reinforced, OMRF-RF1, RF2, concepts. In addition one can observe that the dogbone frame with reduced column cross-section, OMRF-DB2, can develop a global type mechanism;
- in case of near-source earthquakes with impulsive characteristics, having many pulses (Kobe, Kalamata), the same conclusions can be marked, but due to the severity of these actions the OMRF-DB2 develops a storey mechanism, the column size reduction being too drastically;

Earthquake	OMRF	SMRF	OMRFB-DB1	OMRFB-DB2	OMRFB-RF1	OMRFB-RF2
Kobe N-S 1995						
Kalamata Long 1986						
Mexico E00W 1985						

Figure 8: Plastic collapse mechanisms

Earthquake	OMRF	SMRF	OMRF-DB1	OMRF-DB2	OMRF-RF1	OMRF-RF2
Northridge N90W 1994						
Aigio Transv. 1995						
Zakynthos Long 1988						

Figure 9: Plastic collapse mechanisms

- in case of near-source earthquakes with impulsive characteristics, having one pulse (Northridge, Aigio), these modified moment resisting frames, OMRF-DB1,DB2, OMRF-RF1,RF2, concentrates the plastic hinges only in the beams avoiding the formation of plastic hinges in the column ends. Also, the same conclusion can be marked in case of near field actions with intermediate characteristics (Zakynthos).

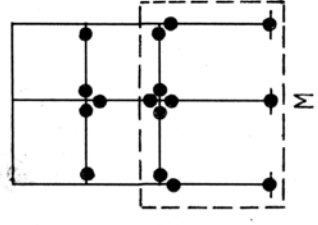
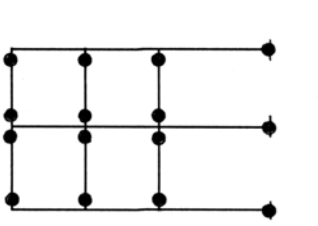
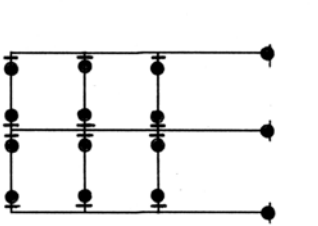
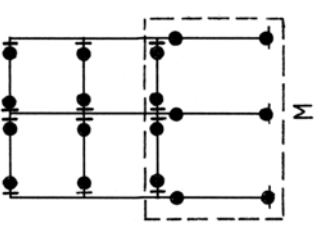
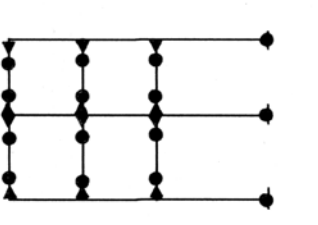
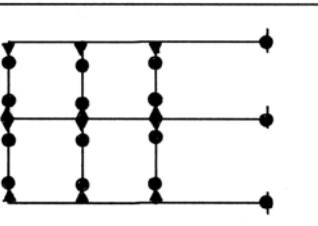
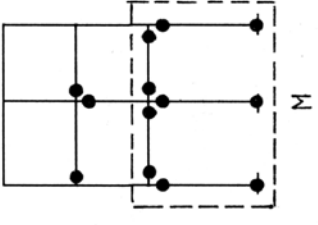
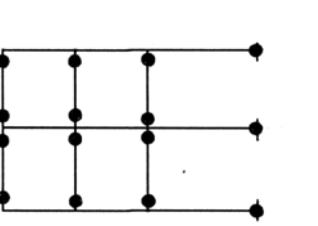
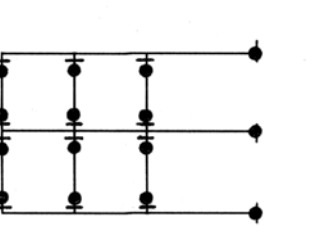
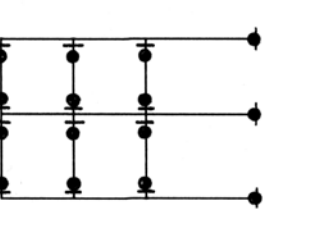
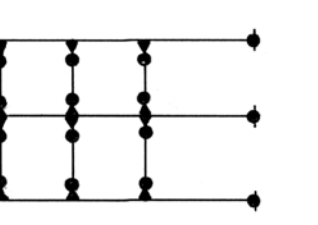
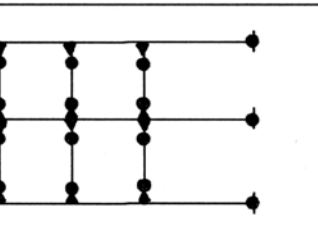
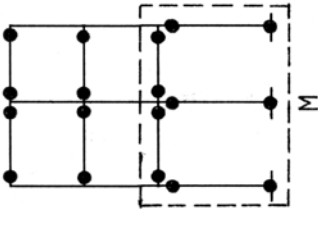
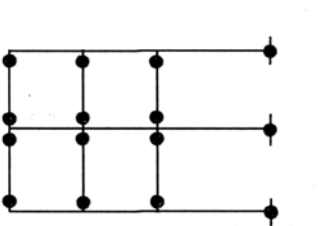
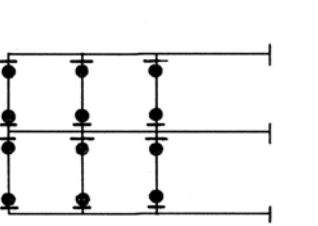
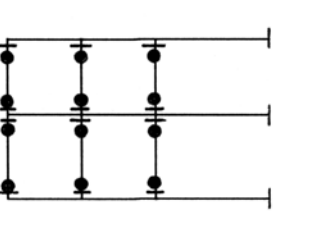
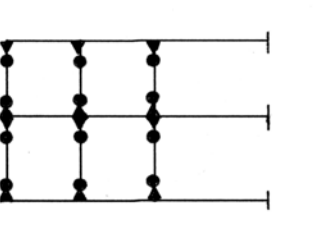
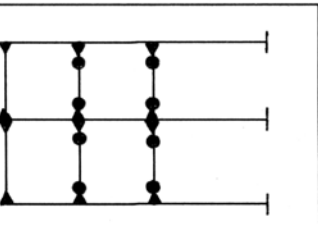
Regarding the position of the developed plastic hinges, one can see that always in case of OMRF-DB1, DB2, and OMRF-RF1, RF2, these plastic hinges are formed away from the column face, the analysis hypothesis being respected.

Studying the ductility demands in the beams, one can be observed that in case of near-source earthquakes having many pulses (Kobe, Kalamata) the required plastic of the OMRF-DB1,DB2 and OMRF-RF1,RF2, is grater than the other frame typologies, OMRF, SMRF, Fig.10a, while in case of far-source and near-source, having one pulse, the required plastic rotation of the OMRF-DB1,2 and OMRF-RF1,2 is smaller, Fig.10a,b. On the other hand, it is clear that in case of the modified moment frames the required plastic rotation in columns is strongly reduced as compared with OMRF and SMRF plastic requirements, independently of ground motion type, Fig. 11a,b .

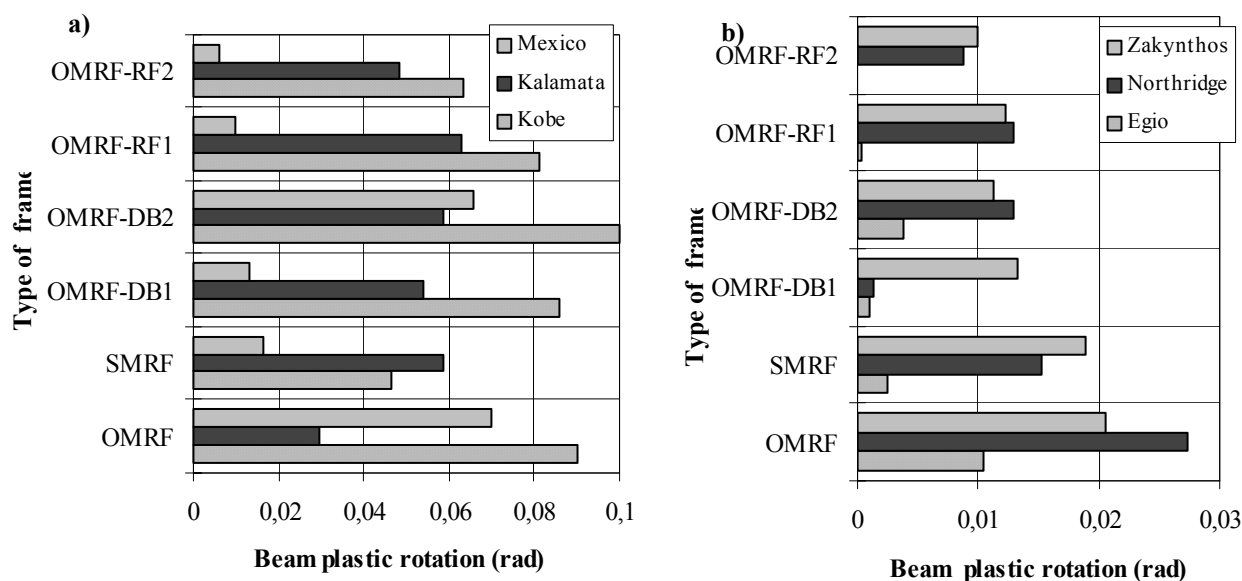

Figure 10: Maximum required plastic rotation in the beams

The comparative analysis of the different frame solution in terms of steel weight is presented in Fig. 12, as compared with the weight of the OMRF, being the cheapest solution. One can see that OMRF-DB1,2 are lighter of about 10% than OMRF and can be achieve a global mechanism with the a structure of about 44% lighter as compared with SMRF. The increasing of column dimensions in case of OMRF-RF2 is proved to be too high, leading to an important increasing of frame weight, without obtaining important improving of the inelastic behaviour.

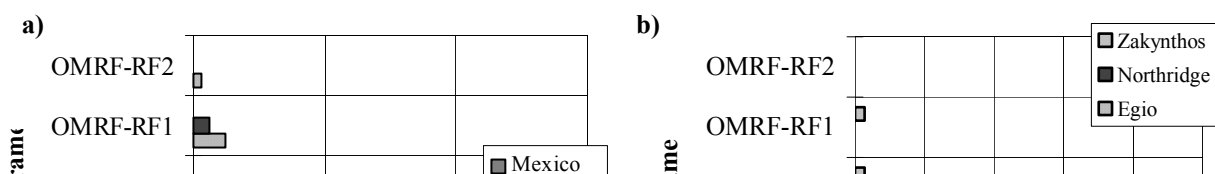

Figure 11: Maximum required plastic rotation in the column ends

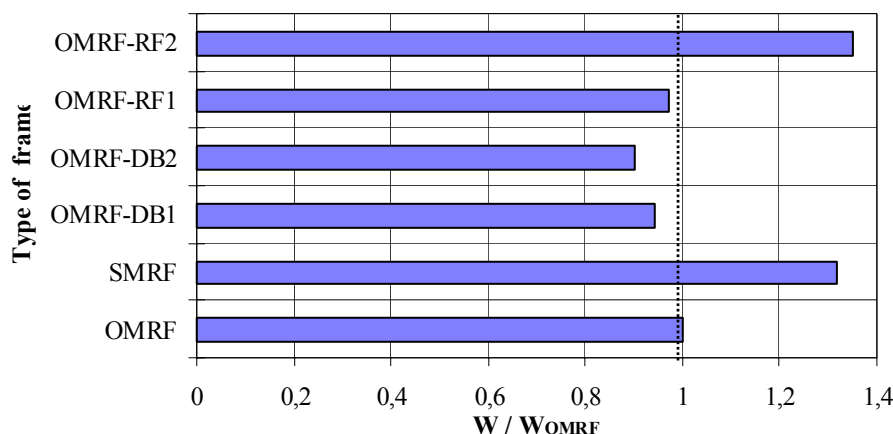

Figure 12: Comparison in terms of structural weight

4. CONCLUSIONS

This paper pointed out the new conforming procedures presenting the basic design considerations for direct sizing, as well as the local and global ductility capacities of these sections. The results from these research work indicate the superiority of the modified moment resisting frames, designed by dogbone and reinforced concept as compared with the other frame typologies, eliminating the high sensitivity to develop storey mechanisms in highly active seismic areas and the forming of plastic hinges in joints. It was clearly evidenced the superiority of the dogbone compared with the reinforced one, from both local and global of view.

REFERENCES

- Anastasiadis A., Mateescu G., Gioncu V., Mazzolani F.M.(1999) Reliability of of joint systems for improving the ductility of MR frames, *Proceedings of the Stability and Ductility of Steel Structures, SDSS Conference, Timisoara, September 9-11*, Elsevier, U.K. (in print)
- Petcu D. and Gioncu V.(1997). DUCTROT'97. Plastic rotation capacity of steel beams and beam-columns. Guid for user, INCERC Timisoara, 1997.
- Mazzolani F.M and Piluso V.(1996).*The theory and Design Of Seismic Resistant Steel Frames, E&FN, London, U.K.*
- Mazzolani F.M , Piluso V.(1994).Manual on Design of Steel Structures in Seismic Zones, ECCS-TC13.

